



## BUTTON INSIGNIA

### MATERIALS

- colored paper
- scissors
- glue
- markers, colored pencils, etc.

### DIRECTIONS

1. Fold the paper in half, using the dashed line as a guide.
2. Cut out the shape following the solid line drawing.
3. Unfold the paper and flip it over. Color as desired.
4. Once completed, glue the finished cut-out on a piece of colored paper.

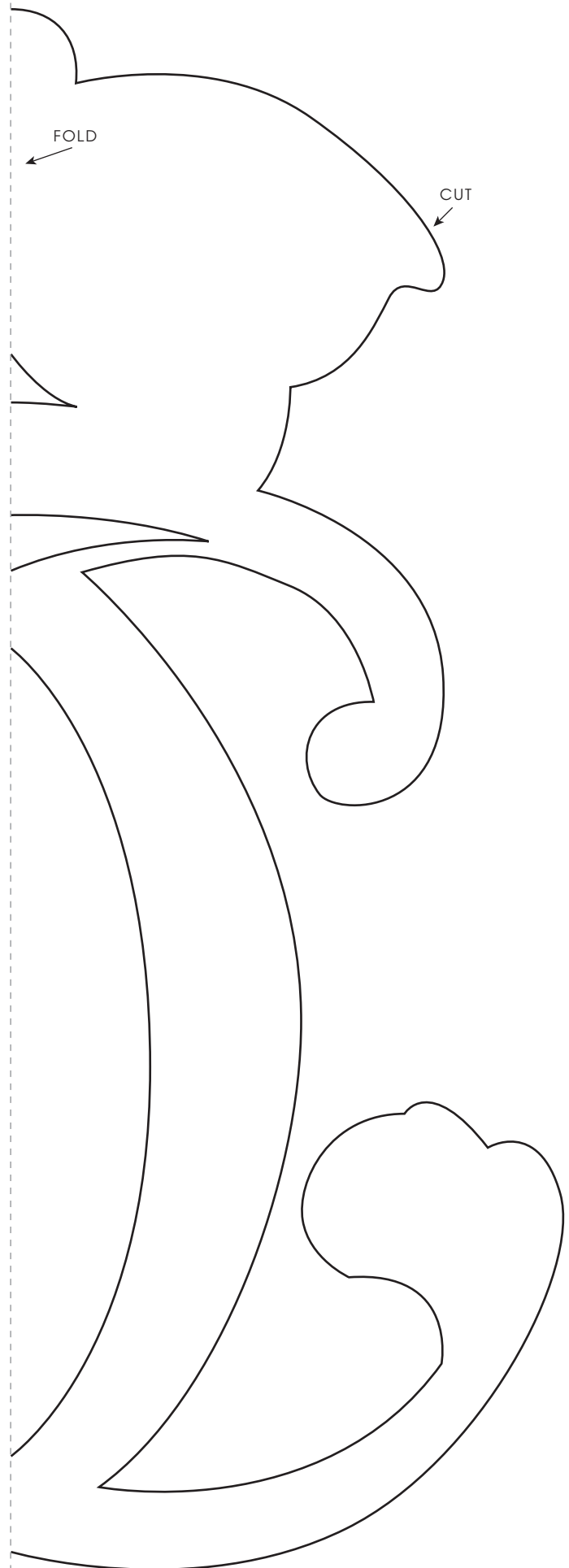

SHARE YOUR WORK WITH US!

## WASHINGTON'S TENT

### MATERIALS

- colored paper
- scissors
- glue
- markers, colored pencils, etc.

### DIRECTIONS

1. Fold the paper in half, using the dashed line as a guide.
2. Cut out the shape following the solid line drawing.
3. Unfold the paper and flip it over. Color as desired.
4. Once completed, glue the finished cut-out on a piece of colored paper.

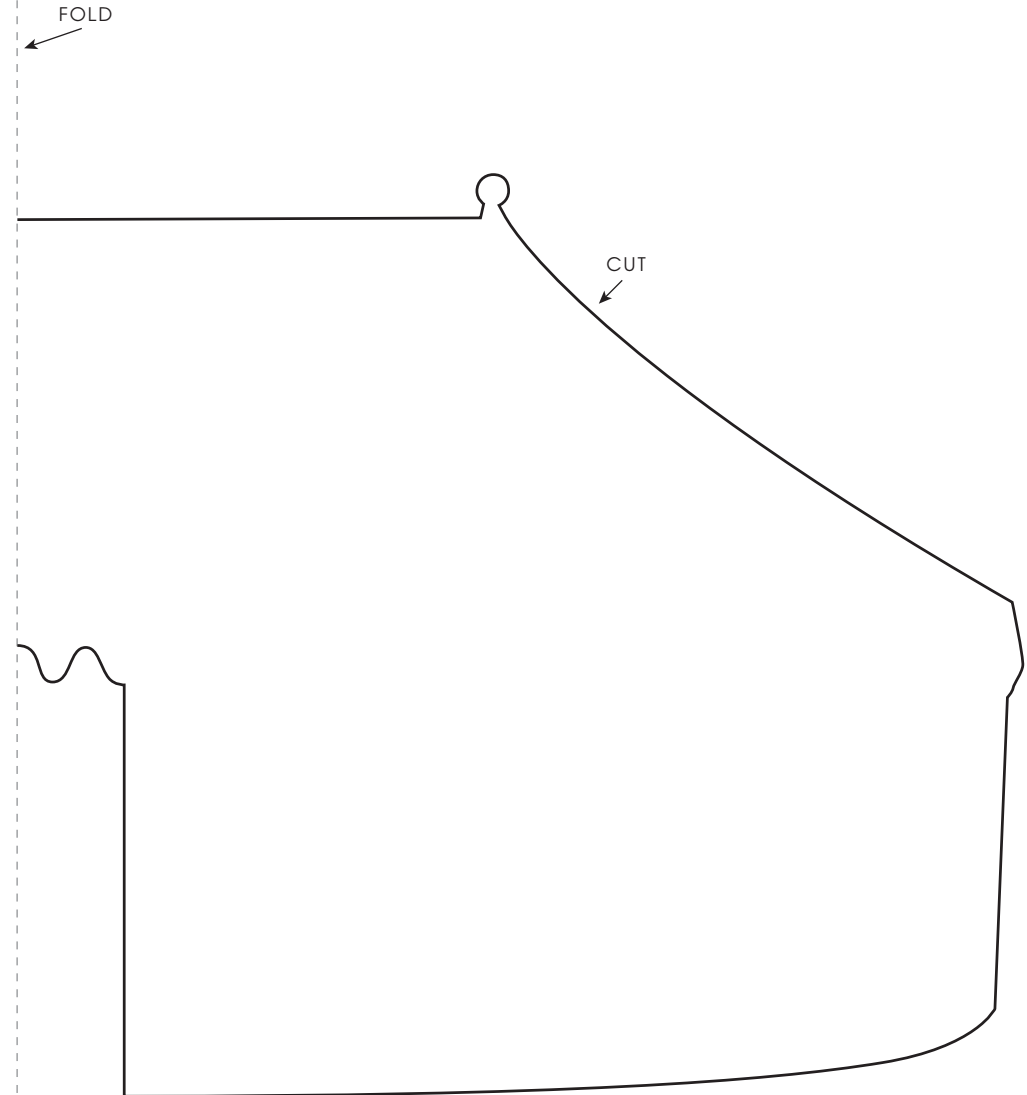

SHARE YOUR WORK WITH US!

## CANDLESTICK

### MATERIALS

- colored paper
- scissors
- glue
- markers, colored pencils, etc.

### DIRECTIONS

1. Fold the paper in half, using the dashed line as a guide.
2. Cut out the shape following the solid line drawing.
3. Unfold the paper and flip it over. Color as desired.
4. Once completed, glue the finished cut-out on a piece of colored paper.

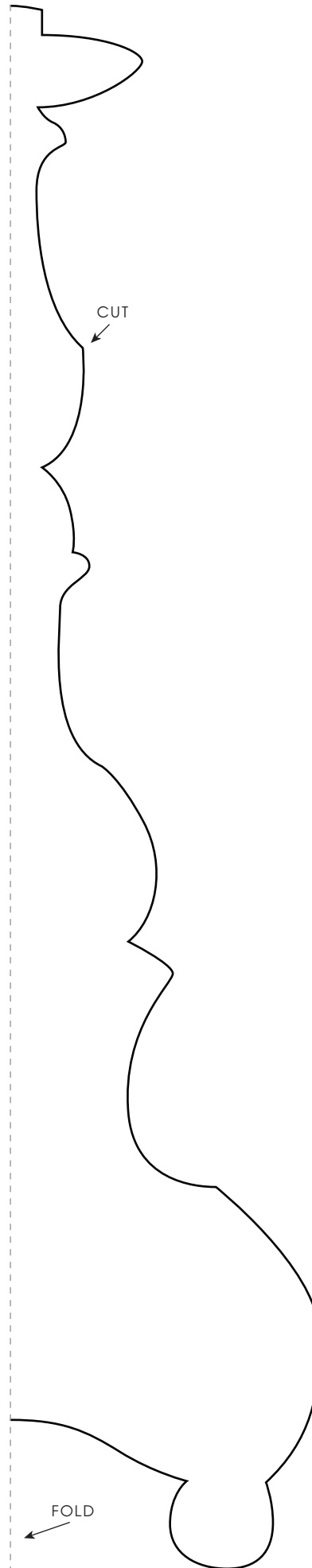

SHARE YOUR WORK WITH US!

**CHAIR** *DIFFICULT*

**MATERIALS**

- colored paper
- scissors
- glue
- markers, colored pencils, etc.

**DIRECTIONS**

1. Fold the paper in half, using the dashed line as a guide.
2. Cut out the shape following the solid line drawing.
3. Unfold the paper and flip it over. Color as desired.
4. Once completed, glue the finished cut-out on a piece of colored paper.

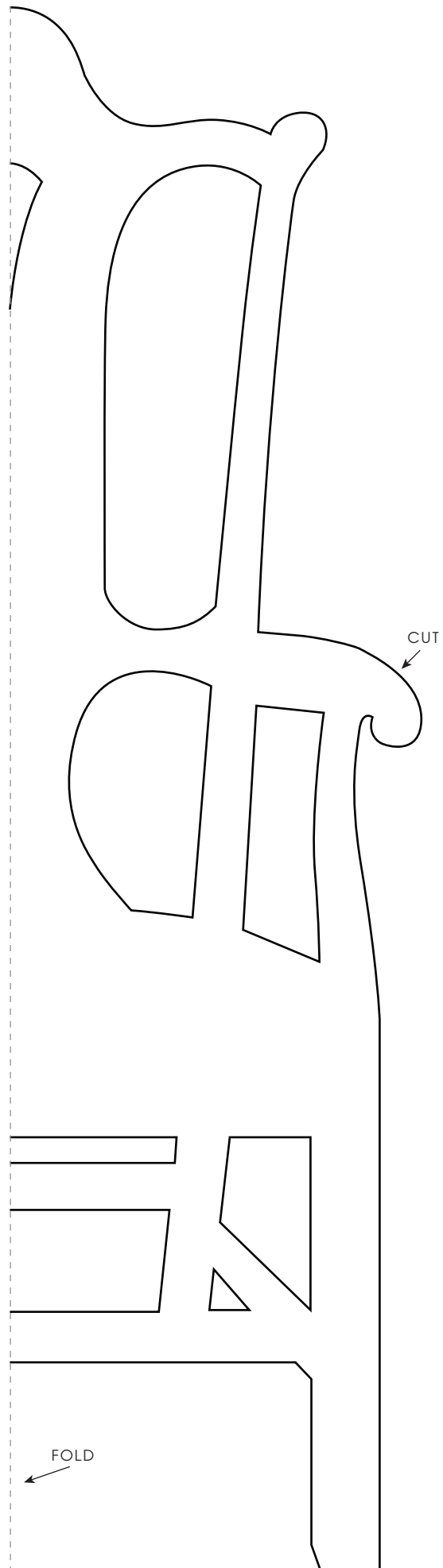

SHARE YOUR WORK WITH US!

**CHAIR** *EASY*

**MATERIALS**

- colored paper
- scissors
- glue
- markers, colored pencils, etc.

**DIRECTIONS**

1. Fold the paper in half, using the dashed line as a guide.
2. Cut out the shape following the solid line drawing.
3. Unfold the paper and flip it over. Color as desired.
4. Once completed, glue the finished cut-out on a piece of colored paper.

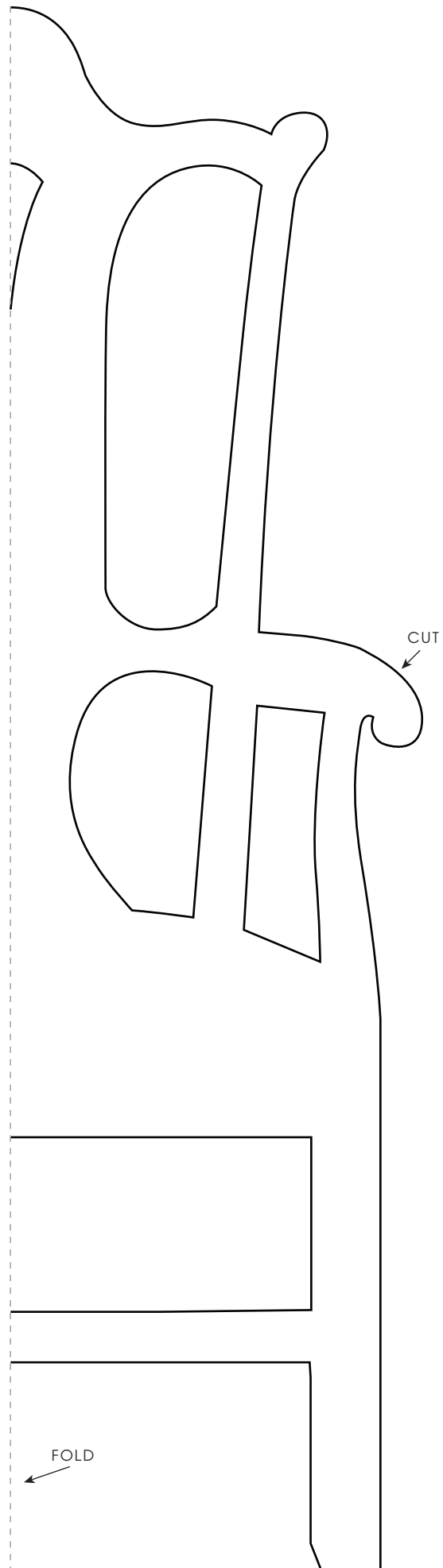

SHARE YOUR WORK WITH US!

## SINGLE FINIAL

### MATERIALS

- colored paper
- scissors
- glue
- markers, colored pencils, etc.

### DIRECTIONS

1. Fold the paper in half, using the dashed line as a guide.
2. Cut out the shape following the solid line drawing.
3. Unfold the paper and flip it over. Color as desired.
4. Once completed, glue the finished cut-out on a piece of colored paper.

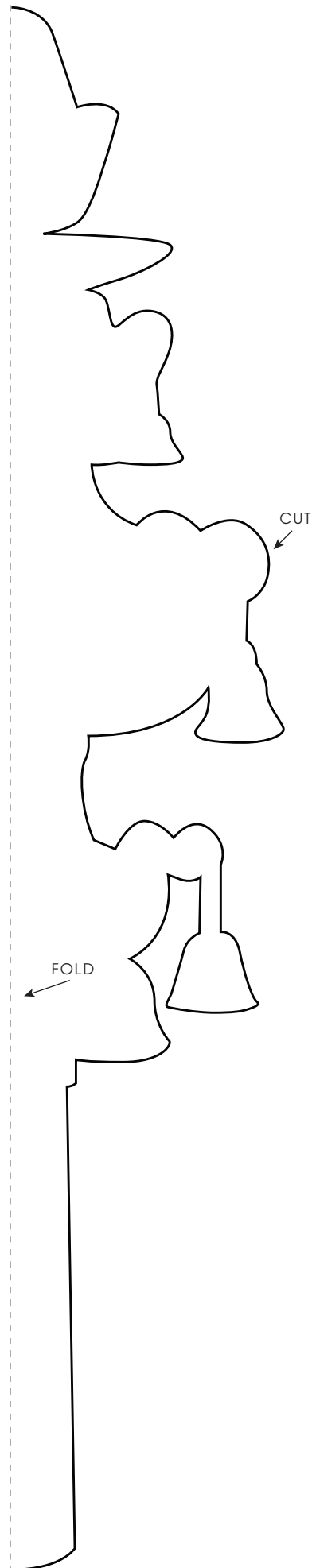

SHARE YOUR WORK WITH US!

## DOUBLE FINIAL

### MATERIALS

- colored paper
- scissors
- glue
- markers, colored pencils, etc.

### DIRECTIONS

1. Fold the paper in half, using the dashed line as a guide.
2. Cut out the shape following the solid line drawing.
3. Unfold the paper and flip it over. Color as desired.
4. Once completed, glue the finished cut-out on a piece of colored paper.

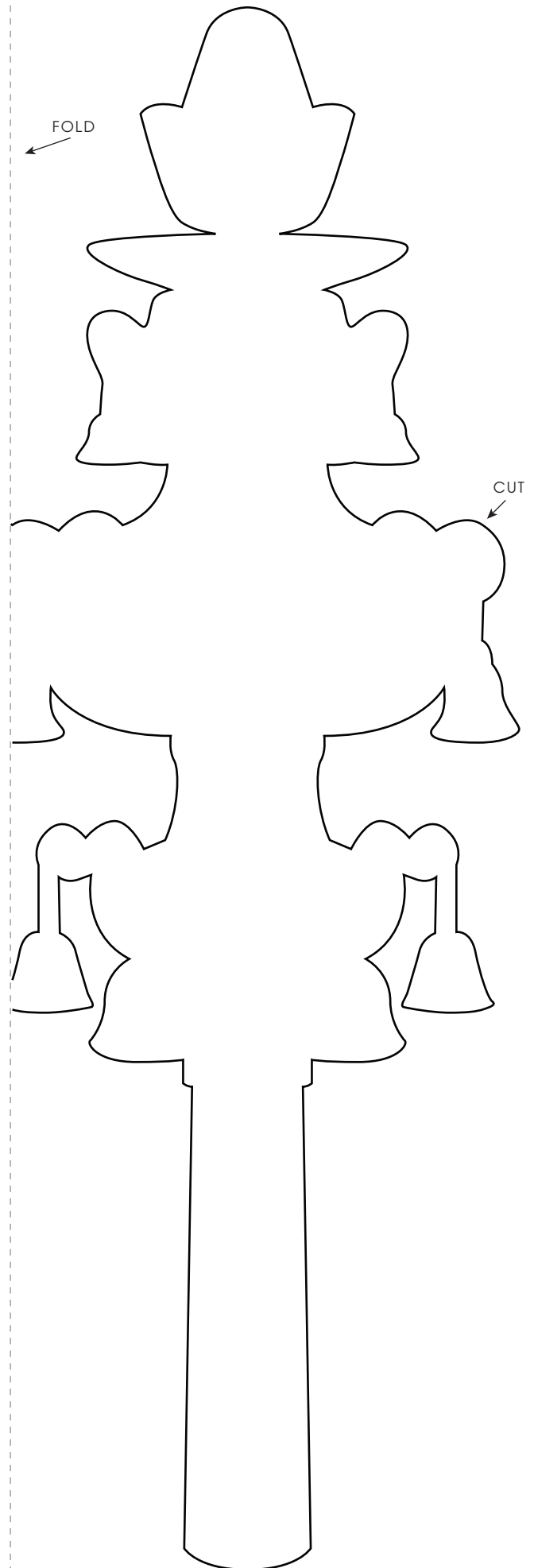

SHARE YOUR WORK WITH US!



## HALBERD *WITH A BORDER*

### MATERIALS

- colored paper
- scissors
- glue
- markers, colored pencils, etc.

### DIRECTIONS

1. Fold the paper in half, using the dashed line as a guide.
2. Cut out the shape following the solid line drawing.
3. Unfold the paper and flip it over. Color as desired.
4. Once completed, glue the finished cut-out on a piece of colored paper.

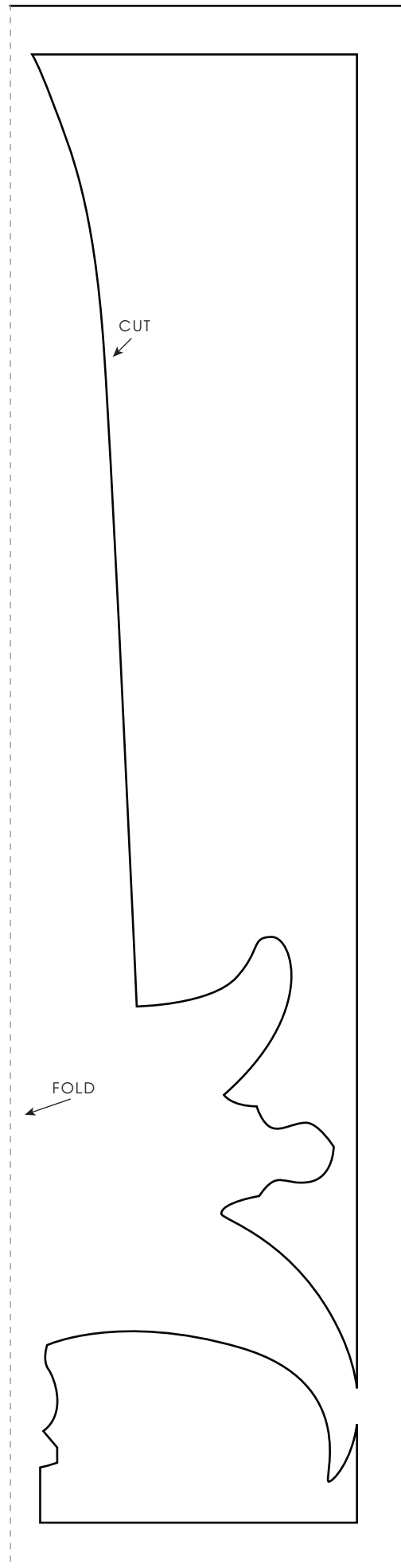

SHARE YOUR WORK WITH US!

## HALBERD

### MATERIALS

- colored paper
- scissors
- glue
- markers, colored pencils, etc.

### DIRECTIONS

1. Fold the paper in half, using the dashed line as a guide.
2. Cut out the shape following the solid line drawing.
3. Unfold the paper and flip it over. Color as desired.
4. Once completed, glue the finished cut-out on a piece of colored paper.

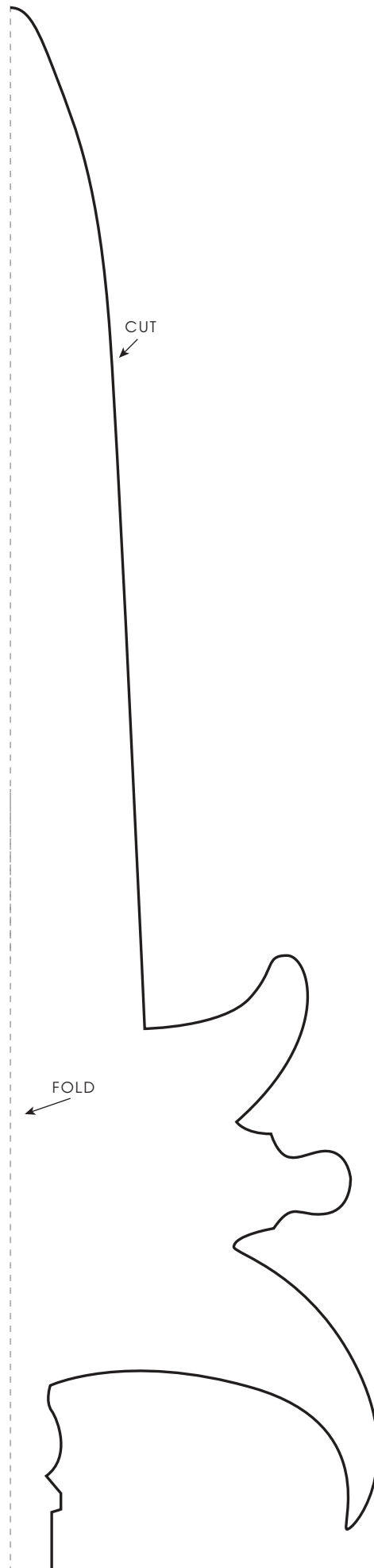

SHARE YOUR WORK WITH US!

## WORDS

### MATERIALS

- colored paper
- scissors
- glue
- markers, colored pencils, etc.

### DIRECTIONS

1. Fold the paper in half, using the dashed line as a guide.
2. Cut out the shape following the solid line drawing.
3. Unfold the paper and flip it over. Color as desired.
4. Once completed, glue the finished cut-out on a piece of colored paper.

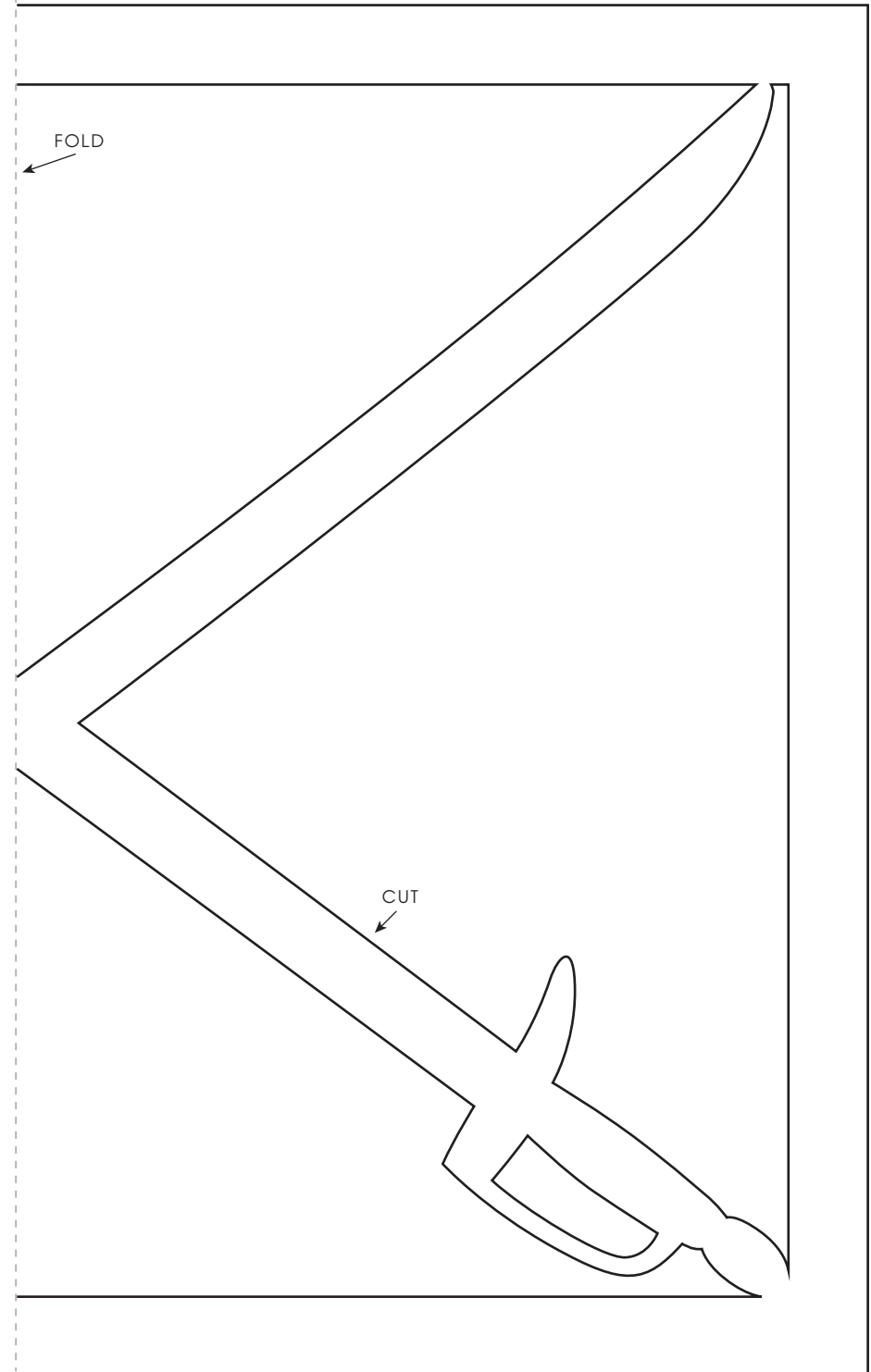

SHARE YOUR WORK WITH US!